



**New England
Water Works Association**

A Section of the
 American Water Works Association

New England Water Works Association

Backflow Prevention Device Assembly Field Test Procedures Utilizing a 3 Valve Test Kit

January 2010

NEW ENGLAND WATER WORKS ASSOCIATION
3 VALVE DIFFERENTIAL TEST KIT
FIELD TEST PROCEDURE
DOUBLE CHECK VALVE ASSEMBLY

This field test procedure evaluates the operational performance characteristics as specified by nationally recognized industry standards of the independently-operating internal spring loaded check valves while the assembly is in a no-flow condition. This field test procedure utilizes a three valve differential pressure test kit to measure the static differential pressure across the check valves. This field test procedure will reliably detect weak or broken check valve springs and validate the test results by determining that a no-flow condition exists while not closing the upstream shut-off valve. This test procedure will work with all three valve differential pressure test kits.

Prior to initiating the test, the following preliminary testing procedures shall be followed:

1. The device has been identified.
2. The direction of flow has been determined.
3. The test cocks have been numbered and adapters have been installed.
4. The test cocks have been flushed.
5. Permission to shut-down the water supply has been obtained.
6. The downstream shut-off valve has been closed. (See NOTE A)
7. The device is inspected and evaluated for a backpressure condition.

The double check valve assembly field test procedure will be performed in the following sequence to evaluate that:

1. The first check valve has a minimum differential pressure across it of 1 PSID.
2. The second valve has a minimum differential pressure across it of 1 PSID.
3. The downstream shut-off valve is tight and/or there is no-flow condition through the assembly (including backflow) or no demand downstream.

NOTE A: Prior to closing the downstream shut-off valve, if it is determined that the device may be prone to backpressure, a standard PSI calibrated pressure gauge should be connected to test cock #2 and test cock #4. The pressure readings (PSI) should be noted.

- a. If the pressure (PSI) reading at test cock #2 is higher than the pressure (PSI) reading at test cock #4, close the downstream shut-off valve and proceed to Step 1, number 3.
- b. If the pressure (PSI) reading at test cock #2 is lower than the reading at test cock #4, the device is in a backpressure condition and the downstream shut-off valve must be closed prior to performing the test of the device.
 - i. After closing the downstream-shut off valve, test cock #4 should be bleed and the pressure readings at test cock #2 and #4 should be noted again. If the pressure reading at test cock #2 is higher than the reading at test cock #4, proceed to Step 1, number 3. If the pressure reading at test cock #2 is still lower than the reading at test cock #4, the downstream shut-off valve is considered leaking and a backpressure condition still exists. The downstream shut-off valve must be reclosed, repaired, or a no-flow condition must be established before testing the device. The device cannot be tested in a backpressure condition.

DOUBLE CHECK VALVE ASSEMBLY 3 VALVE FIELD TEST PROCEDURE

Step 1: Test the first check valve to determine that it has a minimum static differential pressure across it of 1 PSI.

1. Verify that upstream shut-off valve is open.
2. Close the downstream shut-off valve (If it is determined that the device is prone to backpressure as in a fire protection system, see NOTE A prior to closing the downstream shut-off valve.)
3. Orientate the test kit. Close high and low control valves on the test kit. Open the vent control valve.
4. Connect the high pressure hose to test cock # 2.
5. Connect the low pressure hose to test cock # 3.
6. Open test cocks # 2 and # 3.
7. Open the high control valve on the test kit to bleed the air from the high pressure hose. Close the high control valve. (Water will bleed through the vent hose.)
8. Open the low control valve on the test kit to bleed the air from the low pressure hose. Close the low control valve. (Water will bleed through the vent hose.)
9. The differential pressure gauge reading should be a minimum of 1 PSID. This differential pressure gauge reading is the apparent reading. This gauge reading cannot be validated until it is confirmed that the device is in a no-flow condition. (See NOTE B)
10. Close test cocks # 2 and # 3. Disconnect the hoses.

NOTE B: If the differential pressure is 0 PSID, this is an indication that the first check valve is leaking and the downstream shut-off valve cannot be tested for tightness using the procedure outlined in Step 3. However, an affirmation can be made that since the first check valve has a differential pressure of 0 PSID, the device is in a no-flow condition. The gauge would record a positive PSID if the device was in a flow condition. The second check valve can and should be tested to determine if the device is providing protection and to validate the no-flow condition.

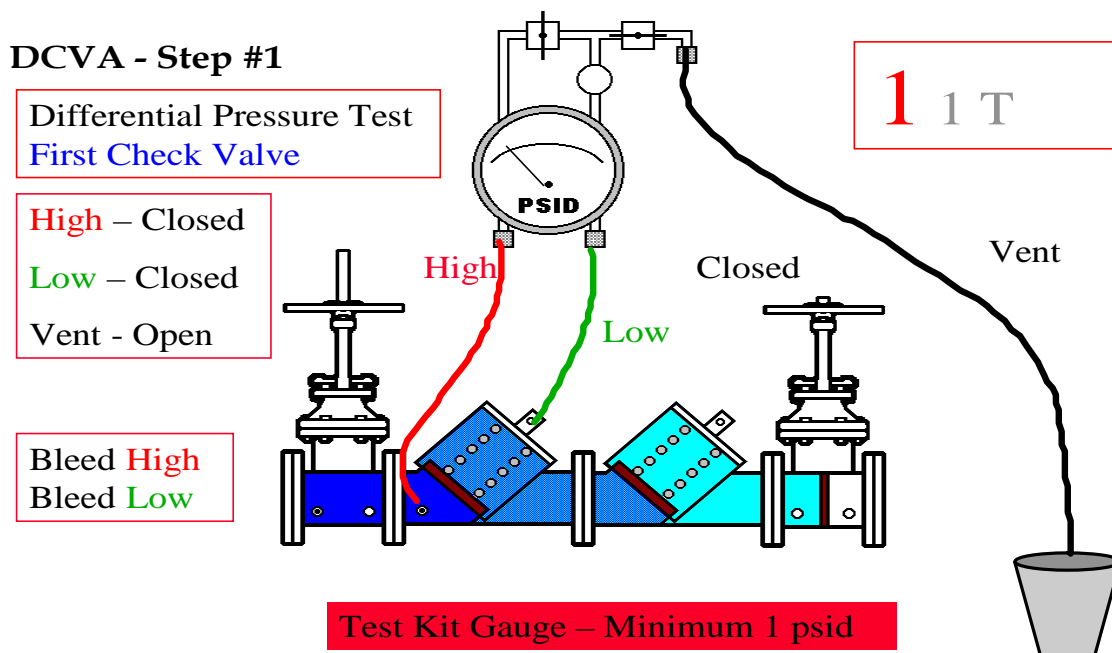

Step 2: Test second check valve to determine that it has a minimum static differential pressure differential across it of 1 PSI.

1. Orientate the test kit valves. Close high and low control valves. Open vent control valve.
2. Connect the high pressure hose to test cock # 3.
3. Connect the low pressure hose to test cock # 4.
4. Open test cocks # 3 and # 4.
5. Open the high control valve on the test kit to bleed the air from the high pressure hose. Close the high control valve.
6. Open the low control valve on the test kit to bleed the air from the low pressure hose. Close the low control valve.
7. The differential pressure gauge reading should be a minimum of 1 PSID. The differential pressure gauge reading is the apparent reading. This gauge reading cannot be validated until it is confirmed that the device is in a no-flow condition. (See NOTE C)
8. Close tests cocks # 3 and # 4. Disconnect the hoses.

NOTE C: If the differential pressure is 0 PSID, this is an indication that the second check valve is leaking and the downstream shut-off valve cannot be tested for tightness using the procedure outlined in Step 3. However, the device should be tested for backpressure, since a 0 PSID reading across the second check valve may be an indication that the downstream shut-off valve is leaking and the device is in a backflow condition.

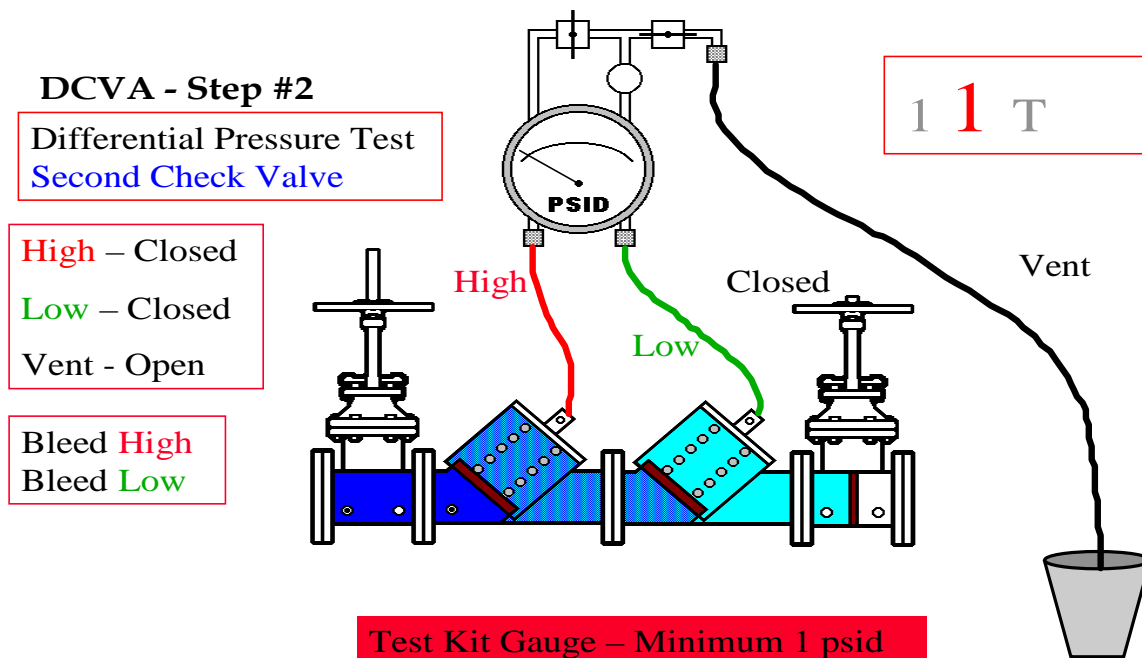

Step 3: Test the Downstream shut-off valve for tightness.

To test the downstream shut-off valve for tightness, both check valves must be tight and holding a minimum differential pressure of 1 PSID, there must be little or no fluctuation of inlet supply pressure. Any backpressure situation should be evaluated. The upstream shut-off valve is open and the downstream shut-off valve is closed.

1. Orientate test kit valves. Close high and low control valves. Open vent control valve.
2. Connect the high pressure hose to test cock # 2 and the low pressure hose to test cock # 3.
3. Open test cocks # 2 and # 3.
4. Open the high control valve on the test kit to bleed air from the high pressure hose. (Water will discharge out of the vent host.) Close the high control valve.
5. Open the low control valve on the test kit to bleed air from the low pressure hose. (Water will discharge out of the vent host.) Close the low control valve.
6. The differential pressure gauge reading should be a minimum of 1 PSID.
7. Elevate the vent hose and open the low control valve to fill vent hose with water. Close the low control valve and connect the vent hose to test cock # 4. Open test cock # 4.
8. Open the test kit high control valve. (This supplies high pressure water downstream of check valve number 2.) If the differential pressure rises, close test cock # 4 immediately. (See NOTE D)
9. Close test cock # 2. (This stops the supply of high pressure water downstream of check valve number 2.)
10. Observe the test kit needle. If the differential pressure gauge reading holds steady, the downstream shut-off valve is recorded as being tight (See NOTE E) If the differential pressure gauge reading drops to zero, the downstream shut-off valve is recorded as leaking (See NOTE F)

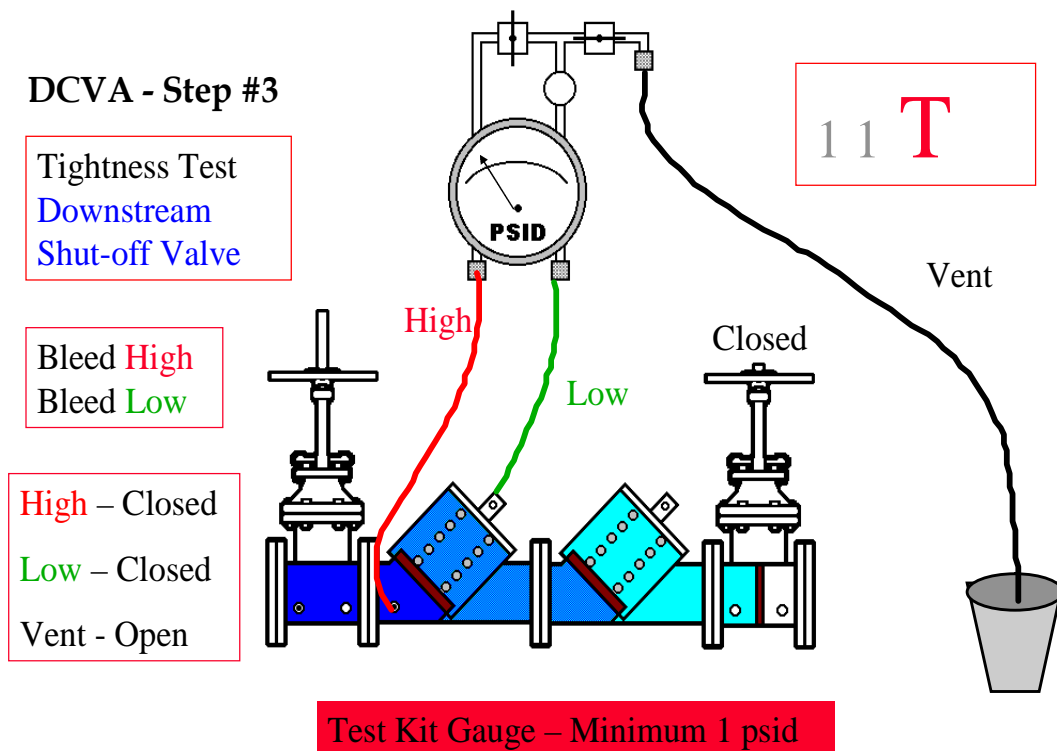

NOTE D: If a backpressure condition is present with a leaking downstream shut-off valve and with the high and vent control valves open, non-potable water will pass through the test kit and be introduced into the potable water supply. If this occurs, test cock #4 should be closed immediately, the test should be discontinued and the test kit should be removed flushed-out with potable water. The assembly should be tested for backpressure as stated above and retested making sure that the downstream shut-off valves is closed tight or no-flow can be achieved and validated.

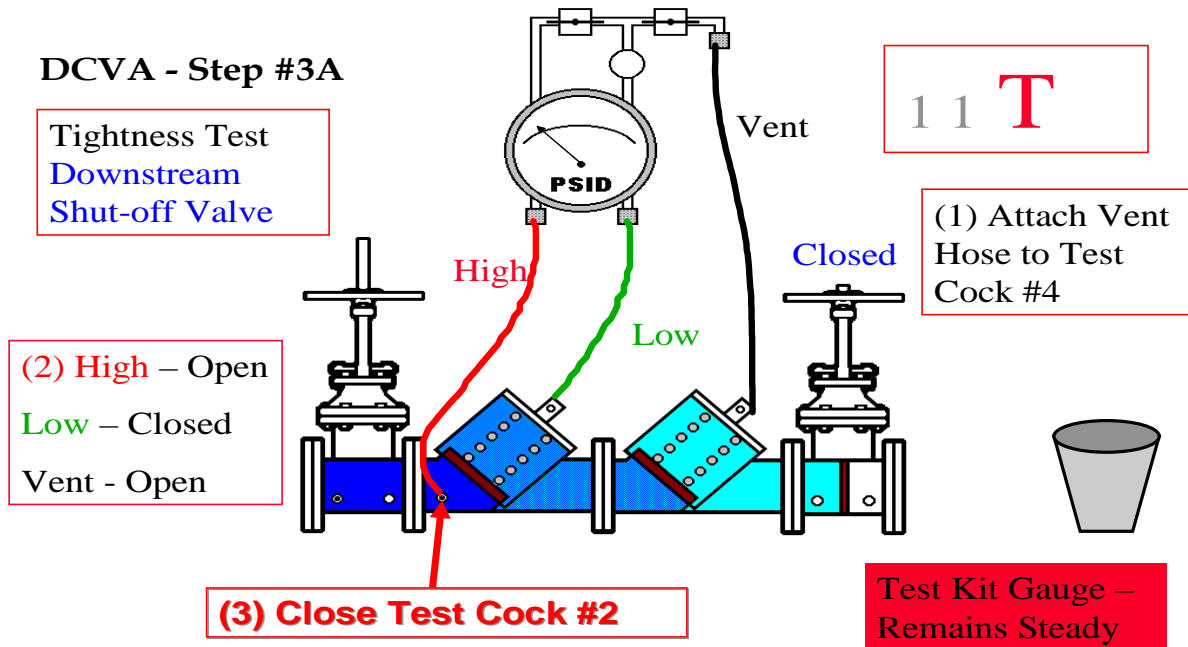

NOTE E: If there is no water demand downstream of the backflow prevention device assembly, the tightness validation of the downstream shut-off valve may not be possible, since a leaking downstream shut-off valve with a no-flow condition will emulate a tight downstream-shut off valve. To validate the condition of the downstream shut-off valve, a demand downstream of the backflow prevention device assembly should be created.

NOTE F: With a leaking downstream shut-off valve, the device is in a flow condition and the previous readings taken are invalid. The device does not fail the test, since it cannot be tested in a flow condition. To proceed with the test of the device, a non-flow condition shall be achieved, either through the repair of the downstream shut-off valve, the operation of an additional shut-off valve downstream or by another means of validating that the device is under a no-flow condition.

Concluding Procedures This completes the standard field test for a double check valve assembly. Before removing the test equipment, the tester should ensure that all test cocks have been closed and the downstream shut-off valve is open, thereby reestablishing flow. All test data should be recorded on appropriate forms.

NEW ENGLAND WATER WORKS ASSOCIATION
3 VALVE DIFFERENTIAL TEST KIT
FIELD TESTING PROCEDURE
REDUCED PRESSURE PRINCIPLE BACKFLOW PREVENTION ASSEMBLY (RPZ)

This field test procedure evaluates the operational performance characteristics as specified by nationally recognized industry standards of the two independently-operating internal spring loaded check valves and a mechanical independently operating hydraulically dependent relief valve located between the check valves while the assembly is in a no-flow condition. This field test procedure utilizes a three valve differential pressure test kit to evaluate the tightness of the both the first and second check valves, measure the static differential pressure across the first and second check valves, and test the operation of the relief valve. This field test procedure will reliably detect weak or broken check valve springs and validate the test results by determining that a no-flow condition exists while not closing the upstream shut-off valve. This test procedure will work with all three valve differential pressure test kits.

Prior to initiating the test, the following preliminary testing procedures shall be followed:

1. The device has been identified.
2. The direction of flow has been determined.
3. The test cocks have been numbered and adapters have been installed.
4. The test cocks have been flushed. (See Note A)
5. Permission to shut down the water supply has been obtained.
6. The downstream shut-off valve has been closed.
7. No water is discharging from the relief valve opening.

The reduce pressure principle backflow prevention assembly field test procedure will be performed in the following sequence to evaluate that:

1. The first check valve will be tested to determine tightness and a minimum differential pressure across the first valve of 5.0 PSID.
2. The second check valve will be tested to determine tightness against backpressure and a minimum differential pressure across the second check valve of 1.0 PSID.
3. The downstream shut-off valve will be testes for tightness and/or the device is in a no-flow condition at the time of the test.
4. The relief valve will be tested to determine if the relief valve opens at a minimum differential pressure of 2 PSID below the inlet supply pressure.

NOTE A: When flushing the test cocks on a reduced pressure principle assembly, test cock #4 should be flushed first and left open with a small amount of flow, while flushing test cock #1, #2, and #3. Once test cocks #1, #2, and #3 have been flushed, close test cock #4. This prevents the premature opening of the relief valve prior to the test.

Reduced Pressure Principle Backflow Prevention Device Assembly 3 Valve Field Test Procedure

Step 1: Test the first check valve to determine if it is tight and has a minimum differential pressure across it of 5 PSID.

1. Verify that the upstream shut-off valve is open.
2. Close the downstream shut-off valve. If no water discharges from the relief valve, the first check valve is considered tight, proceed with the test. If water discharges from the relief valves, the first check valve is considered leaking and it must be repaired prior to completing the test.
3. Orientate the test kit --- close the high and low control valves on test kit. Open the test kit bleeder/vent control valve.
4. Connect the high pressure hose to test cock # 2.
5. Connect the low pressure hose to test cock # 3.
6. Open test cocks # 2 and # 3.
7. Open the high control valve on the test kit to bleed the air from the high pressure hose.
8. Close the high control valve.
9. Open the low control valve on the test kit to bleed the air from the low pressure hose.
10. Close the low control valve.
11. The differential pressure gauge reading should be a minimum of 5 PSID. This differential pressure gauge reading is the apparent reading and it cannot be validated until it is confirmed that the device is in a no-flow condition.

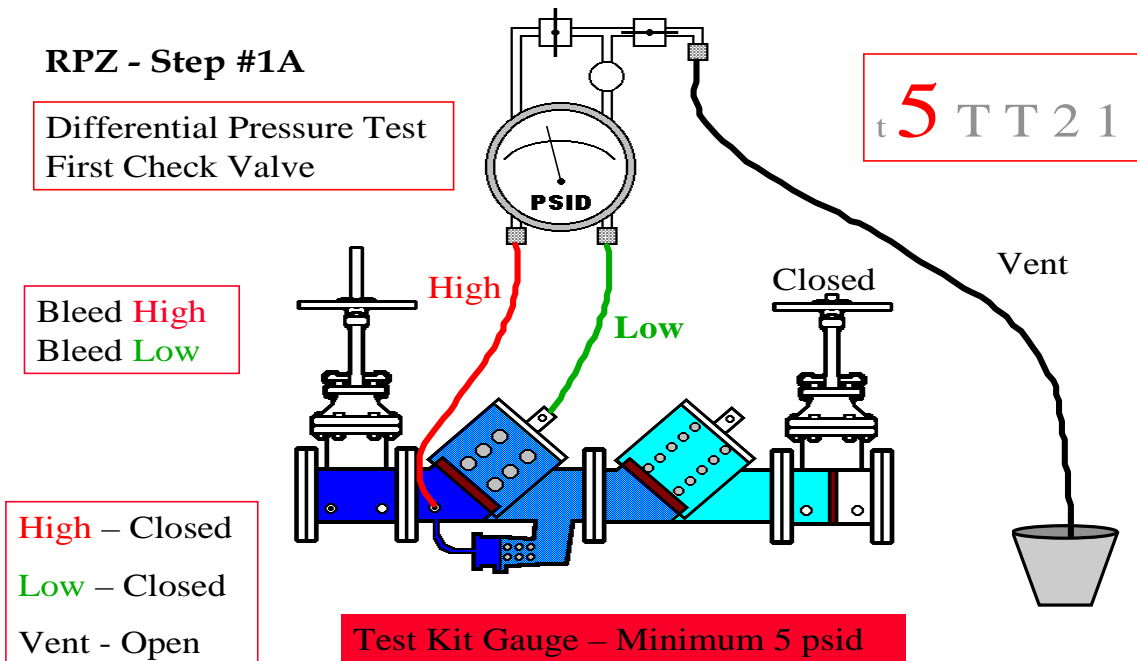

Step 2: Test the tightness of the second check valve against backpressure.

1. The test kit valves and hoses are in the same position as at the conclusion of Step 1. (High and low control valves are closed and the vent control valve is open.)
2. Elevate the vent hose and open the low control test kit valve to fill vent hose with water. Close the low control test kit valve.
3. Connect the water filled vent hose to test cock #4 and open test cock #4.
4. Open the high control test kit valve. (This supplies high pressure water to the downstream side of second check valve. If the differential pressure rises, close test cock # 4 immediately. (See NOTE C) The second check valve is considered tight if the differential pressure gauge remains steady and no water is discharging from the relief valve. If the differential pressure gauge reading on the test kit drops and water discharges from the relief valve, the second check is leaking. (See NOTE B)

NOTE B: If the second check valve is leaking, the downstream shut-off valve and/or the no-flow test (Step 3) cannot be performed. However, an affirmation can be made that since water is discharging from the relief valve, the downstream shut-off valve is considered tight or the device is in a no-flow condition. The differential pressure test across the second check valve (Step 5) cannot be performed since the result would be 0 PSID. However, the relief valve can and should be tested. To test the relief valve with a failed second check valve, close test cock # 4 and proceed to Step 4 - 2.

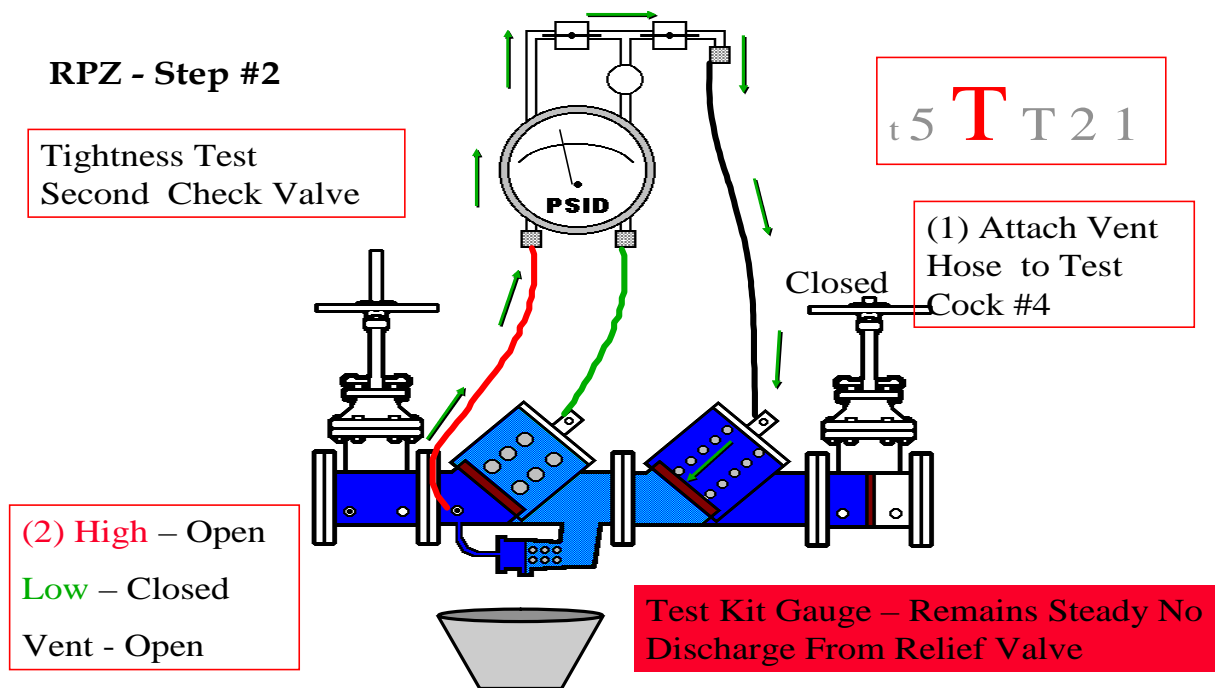

NOTE C: If the differential pressure reading on the test kit increases when the high control test kit valves is opened, (as stated in Step 2, number 4) the device may be in a backflow condition with a leaking downstream shut-off valve. (High pressure water is flowing back through the leaking downstream shut-off valve, through test cock #4 through the test kit to test cock # 2 and into the potable water supply.) If this occurs, test cock #4 should be closed immediately and the test should be terminated. The test kit should be removed and flushed-out with potable water. Attempts should be made to reclose the downstream shut-off valve and a pressure gauge should be used to test for backpressure prior to retesting the assembly. The downstream shut-off valve should be confirmed closed or a no-flow condition achieved and validated prior to conducting the test of the assembly. (The downstream shut-off valve may need to be repaired or replaced.)

Step 3: Test the downstream shut-off valve for tightness to determine that the device is under a no-flow condition and validate differential pressure readings.

1. The test kit valves and hoses are positioned as at the conclusion of Step 2.
2. **Close test cock # 2.** (This stops the supply of high pressure water downstream of the second check valve.)
3. Observe the test kit needle. If the differential pressure gauge reading holds steady, the downstream shut-off valve is tight and/or the device is under a no-flow condition. If the differential pressure gauge drops to zero, the downstream shut-off valve is leaking and the device is in a flow condition. (See Note D)
4. **Open test cock # 2.**

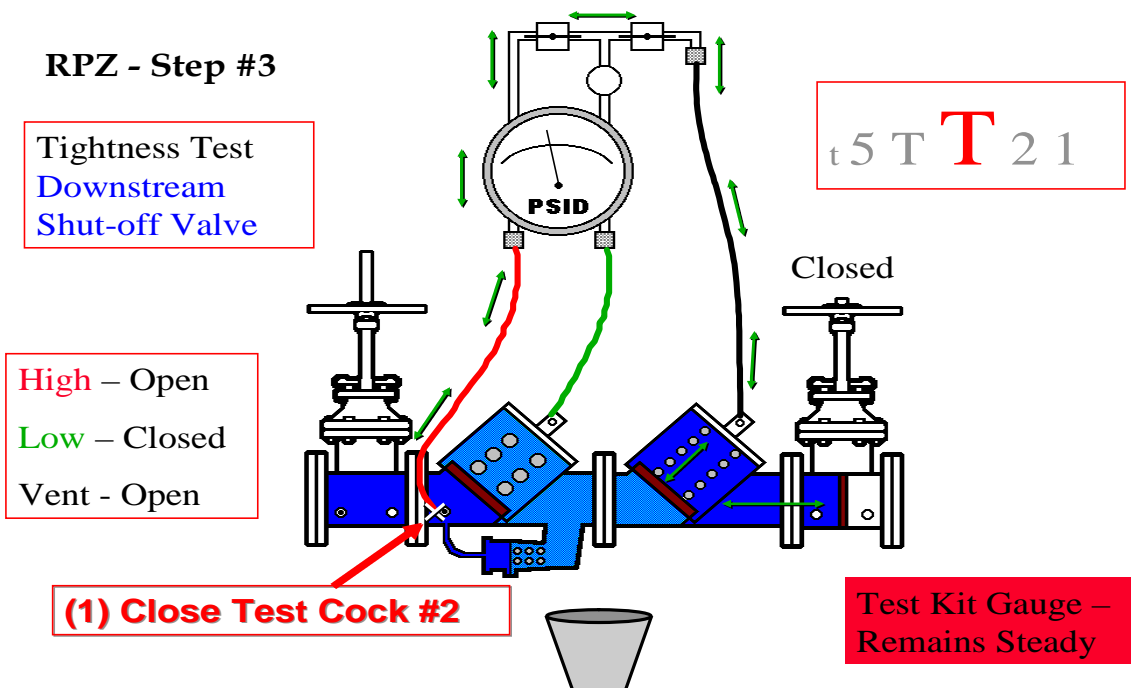

NOTE D: If the device is in a flow condition, the PSID readings previously taken are invalid and the device must be retested once a no-flow condition can be achieved. The device does not fail the test, since it cannot be tested in a flow condition. A no-flow condition shall be achieved, either through the repair of the downstream shut-off valve, the operation of an additional shut-off valve downstream or by another means of validating that the device is in a no-flow condition. A compensating temporary by-pass hose may be used in some cases. (See NEWWA Use of a Bypass Hose in Reduced Pressure Principle Backflow Prevention Device Testing).

Step 4: Test the relief valve to determine that it opens at a minimum differential pressure of 2 PSID below the inlet supply pressure.

1. The test kit valves and the hoses are positioned as at the conclusion of Step 3. Test cock #2 should be open.
2. Slowly open the test kit low control needle valve $\frac{1}{4}$ turn.
3. Record the differential pressure gauge reading at the point when water initially drips from the relief valve opening. The differential pressure gauge reading should be a minimum of 2 PSID. If water does not discharge from the relief valve it may be jammed (intentionally), the sensing line may be clogged, or the diaphragm cannot open due to mechanical wear.

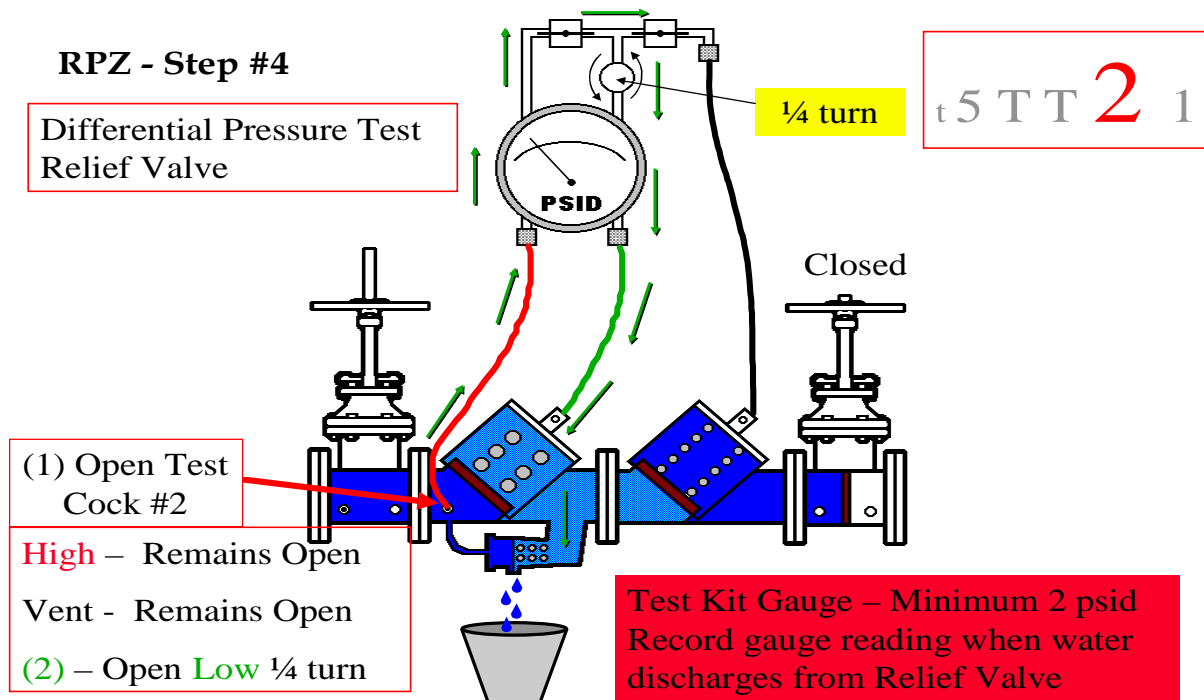

Step 5 : Test the Second Check Valve Differential Pressure (optional)

Testing the differential pressure across the second check valve will validate the tightness of the downstream shut-off valve and determine if a backpressure condition exists. If the downstream valve is leaking and the device is in a flow condition, the differential pressure test across the second check valve cannot be performed.

1. Orientate the test kit --- close high and low control valves. Open the vent control valve.
2. Connect the high pressure hose to test cock # 3.
3. Connect the low pressure hose to test cock # 4.
4. Open test cocks # 3 and # 4.
5. Open the high control valve on the test kit to bleed the air from the high pressure hose.
6. Close the high control valve.
7. Open the low control valve on the test kit to bleed the air from the low pressure hose.
8. Close the low control valve.
9. Record the differential pressure gauge reading. It should be a minimum of 1 PSID, if the second check valve was held tight against backpressure. If the differential pressure reading across the second check valve is 0 PSID this is an indication that the downstream shut-off valve is leaking and the device is under a backpressure condition.

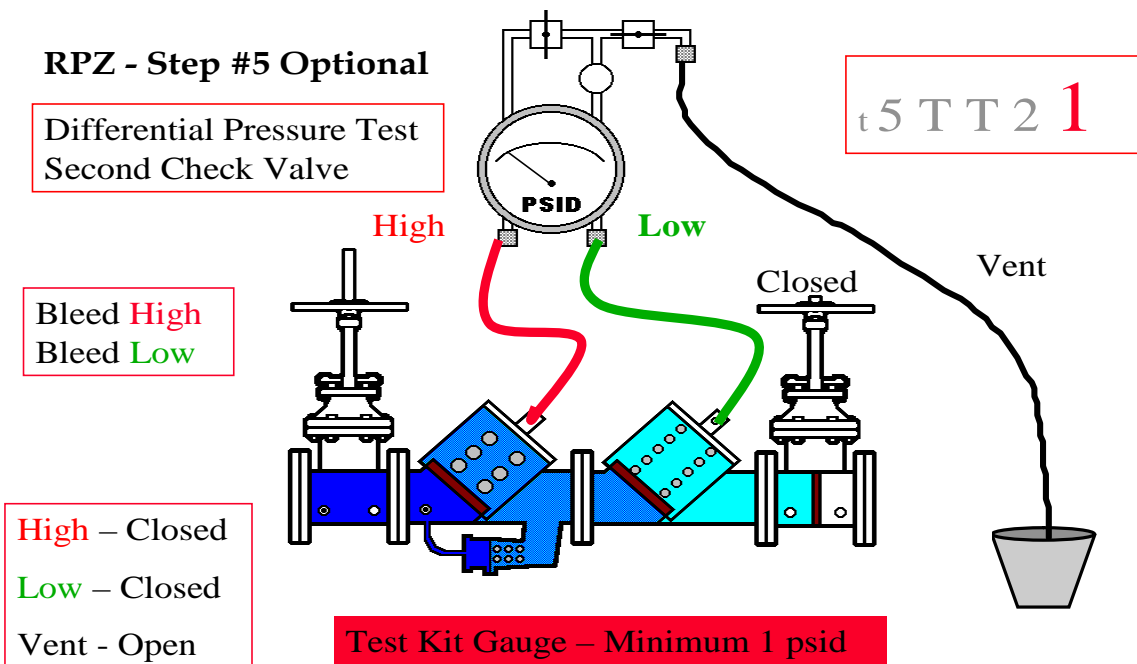

Concluding Procedures This completes the standard field test for a reduced pressure principle backflow prevention device. Before removal of the test equipment, the tester should ensure that the test cocks have been closed, and the downstream shut-off valve is open, thereby reestablishing flow. All test data should be recorded on appropriate forms.

NEW ENGLAND WATER WORKS ASSOCIATION
3 VALVE DIFFERENTIAL TEST KIT
FIELD TESTING PROCEDURE
PRESSURE VACUUM BREAKER

This field test procedure evaluates the operational performance characteristics as specified by nationally recognized industry standards of the independently-operating internal spring loaded check valve and air inlet valve while the assembly is in a no-flow condition. This field test procedure utilizes a three valve differential pressure test kit to measure the static differential pressure across the check valve and determine the opening point of the air inlet valve. This field test procedure will reliably detect weak or broken check valve springs and validate the test results by determining that a no-flow condition exists. This test procedure will work with all three valve differential pressure test kits.

Prior to initiating the test, the following preliminary testing procedures shall be followed:

1. The device has been identified.
2. The direction of flow has been determined.
3. The test cocks have been numbered and the hood is removed.
4. Test adapters have been installed and “blown-out”.
5. Permission to shut down the water supply has been obtained.
6. The downstream shut-off valve has been closed.

This test procedure will examine the pressure vacuum breaker assembly for the following performance characteristics using a three valve differential pressure gauge with a range of 0 – 15 PSID.

1. The check valve has a minimum differential pressure across it of 1 PSID.
2. The downstream shut-off valve is closed tight and/or a no-flow condition exists.
3. The air inlet valve opens at least 1 PSID above atmospheric pressure.

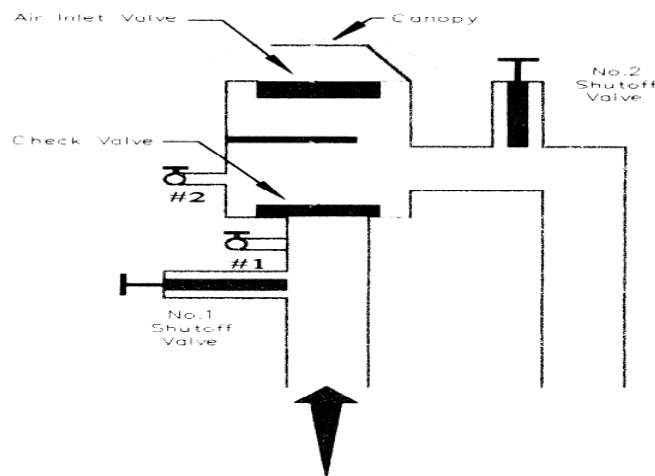

PRESSURE VACUUM BREAKER 3 VALVE FIELD TEST PROCEDURE

Step 1: Test the check valve to determine that it has a minimum differential pressure across it of 1 PSID.

1. Verify that upstream shut-off valve is open.
2. Close the downstream shut-off valve.
3. Orientate test kit. Close high and low control valves. Open vent control valve.
4. Connect the high pressure hose to test cock # 1.
5. Connect the low pressure hose to test cock # 2.
6. Place the vent hose into a bucket or suitable drainage area.
7. Open test cock # 1 and test cock # 2.
8. Open the high control valve; bleed water through the vent hose.
9. Close high control valve.
10. Open the low control valve; bleed water through the vent hose.
11. Close low control valve.
12. Observe needle on test kit is should be 1 PSID or greater. The differential pressure gauge reading is the apparent reading. This gauge reading cannot be validated until it is confirmed that the device is under a no-flow condition.
13. Shut off test cock # 1 and # 2.
14. Remove hoses from the device.
15. Proceed to **Step 2**.

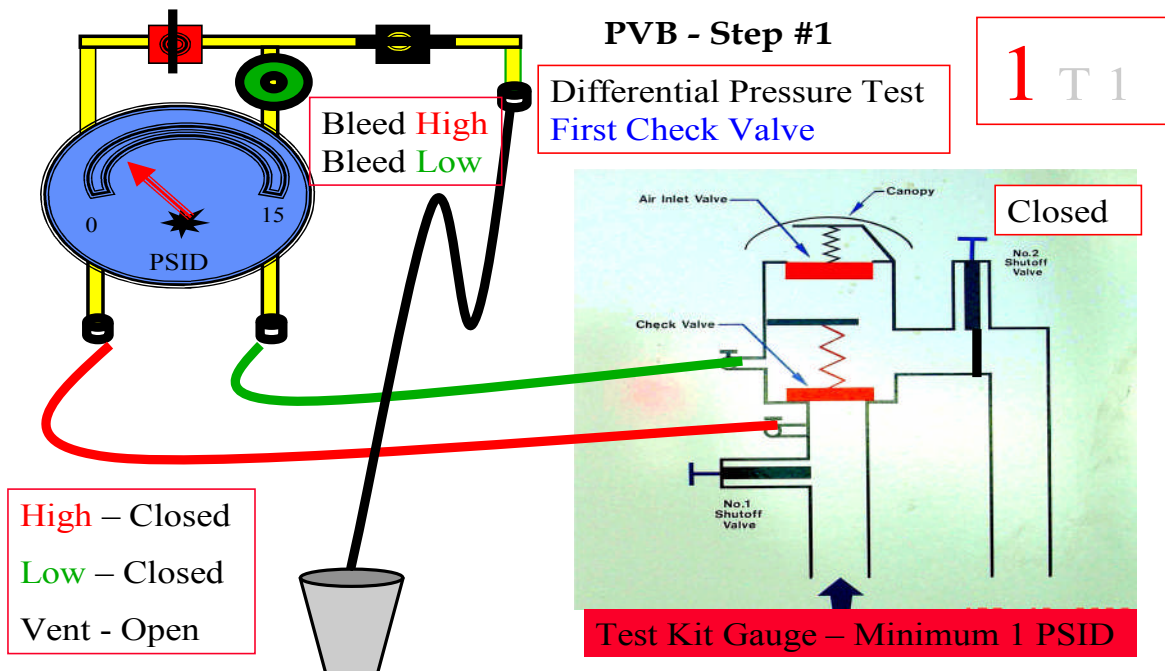

Step 2: Test the downstream shut-off valve for tightness to determine that the device is under a no-flow condition and validate differential pressure reading.

1. Downstream shut-off valve remains closed and upstream shut-off valve remains open.
2. Place low pressure and vent hoses in a bucket or suitable drainage area.
3. Connect high pressure hose to test cock # 2.
4. Position the test kit valves: high and low control valve closed; vent control valve open.
5. Open test cock # 2.
6. The test kit needle should “peg” to the extreme right of the gauge.
7. Open high control valve to bleed air, close the high control valve.
8. Close the upstream shut-off valve. (This stops the supply of high pressure water to the device)
9. Observe needle on Test Kit. If the needle remains steady, the downstream shut-off valve is holding tight and/or the device is in a no-flow condition. If needle starts to descend to zero, the downstream shut-off valve is considered leaking (see NOTE A).
10. Proceed to **Step 3** if a no-flow condition exists.

NOTE A: If the device is in a flow condition the differential reading taken is invalid. The device does not fail the test; it cannot be tested since it is in a flow condition. To perform the test of the device, a non-flow condition shall be achieved, either through the repair of the downstream shut-off valve, the operation of an additional shut-off valve downstream or by another means of validating that the device is under a no-flow condition.

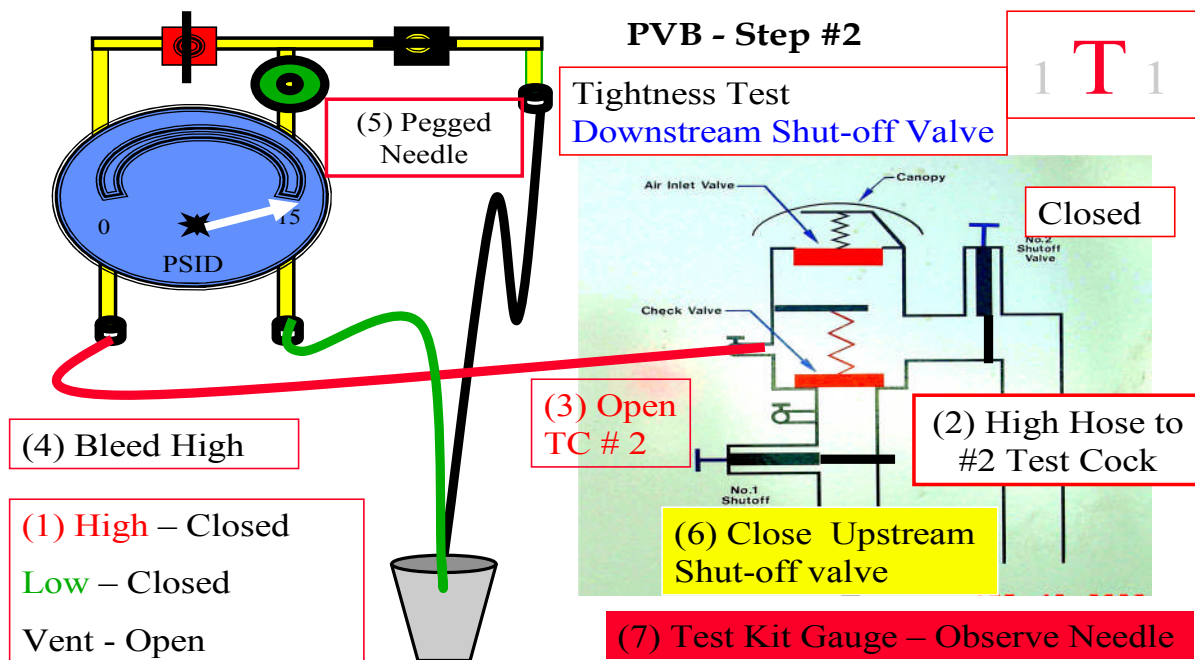

Numbers on illustration may not correlate with the step numbers above.

Step 3: Determine if the air inlet valve opens at least 1 PSID above atmospheric pressure.

1. Both shut-off valves are still closed.
2. The high pressure hose is still connected to the open test cock # 2.
3. The low pressure and vent hoses are still in a bucket or suitable drainage area.
4. The test kit valves are positioned as follows: High and low control valve closed; Vent control valve is open.
5. Elevate the test kit and the end of low pressure hose to the same level as test cock # 2.
6. Slowly open the high control valve while simultaneously observing the air inlet valve. (Lightly placing an object on top of the air inlet may be helpful in determine the opening point.)
7. Observe the test kit needle at the point where the air inlet valve opens (pops). The air inlet should open at a minimum of 1 PSID or greater. If the air inlet valve does not open, the upstream shut-off valve may be leaking.
8. Observe that the air inlet valve to determine that it is open completely.

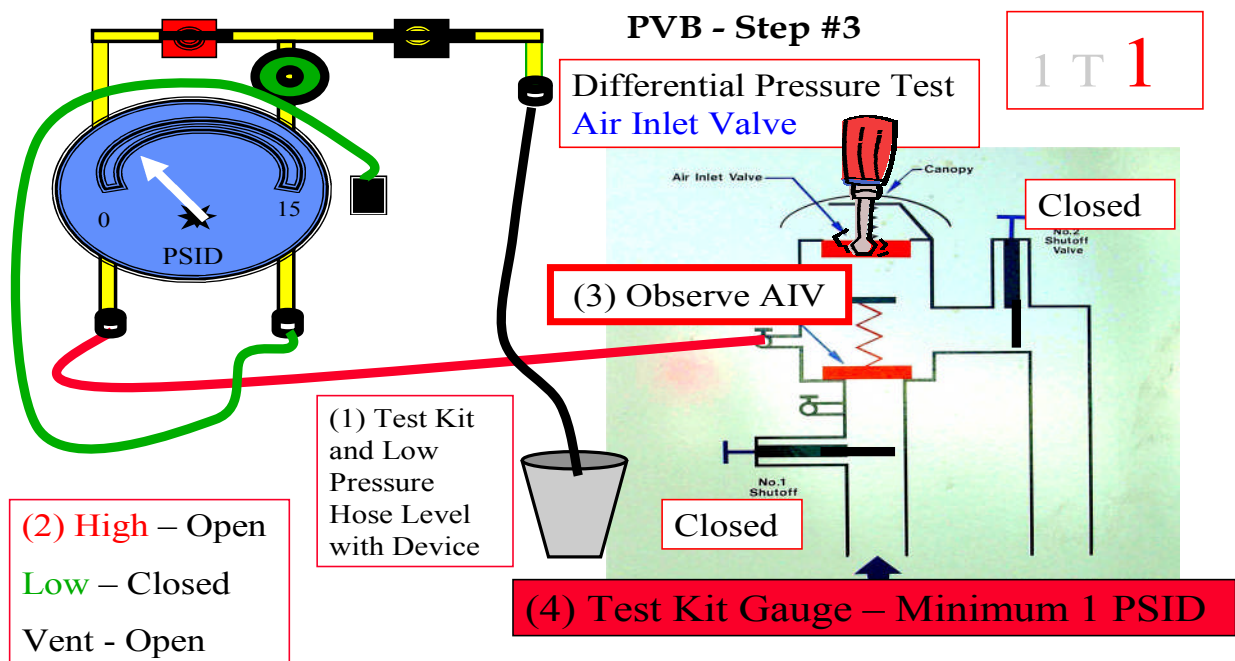

Numbers on illustration do not correlate with the step numbers above.

Concluding Procedures This completes the standard field test for a Pressure Vacuum Breaker. Before removal of the test equipment, the tester should ensure that the test cocks have been closed, and the downstream and upstream shut-off valves are open, thereby reestablishing flow. All test data should be recorded on appropriate forms.

NEW ENGLAND WATER WORKS ASSOCIATION
3 VALVE TEST KIT FIELD TESTING PROCEDURE
SPILL-RESISTANT PRESSURE VACUUM BREAKER

This field test procedure evaluates the operational performance characteristics as specified by nationally recognized industry standards of the independently-operating internal spring loaded check valve and air inlet valve while the assembly is in a no-flow condition. This field test procedure utilizes a three valve differential pressure test kit to measure the static differential pressure across the check valve and determine the opening point of the air inlet valve. This field test procedure will reliably detect weak or broken check valve springs and validate the test results by determining that a no-flow condition exists. This test procedure will work with all three valve differential pressure test kits.

Prior to initiating the test, the following preliminary testing procedures shall be followed:

1. The device has been identified.
2. The direction of flow has been determined.
3. The test cocks have been numbered and the canopy is removed.
4. A test adapter has been installed and “blown-out”.
5. Permission to shut down the water supply has been obtained.
6. The downstream shut-off valve has been shut off.

This test procedure will examine the spill resistant pressure vacuum breaker assembly for the following performance characteristics using a three valve differential pressure gauge with a range of 0 – 15 PSID.

1. The check valve has a minimum differential pressure across it of 1 PSID.
2. The downstream shut-off valve is closed tight and/or a no-flow condition exists.
3. The air inlet valve opens at least 1 PSID above atmospheric pressure.

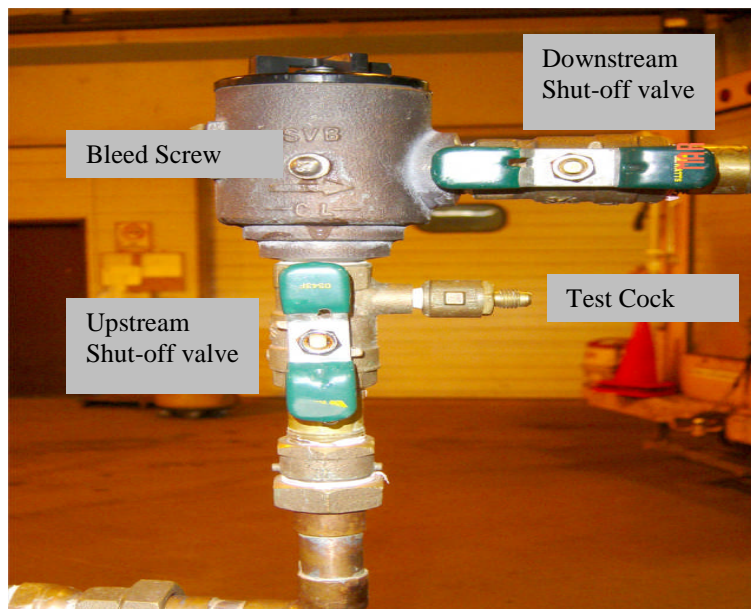

SPILL RESISTANT PRESSURE VACUUM BREAKER
3 VALVE FIELD TEST PROCEDURE

Step 1: Test the check valve to determine that it has a minimum differential pressure across it of 1 PSID (Figure 1)

1. Verify that upstream shut-off valve is open.
2. Close the downstream shut-off valve.
3. Orientate the test kit valves – high and low control valves closed; vent control valve open.
4. Connect the high hose to the test cock.
5. Open the test cock. The test kit needle should peg to the extreme right of the gauge.
6. Open high control valve to bleed air from the hose; close the high control valve.
7. Close the upstream shut-off valve.
8. Raise test kit and end of the low pressure hose to the elevation of the test cock.
9. Slowly unscrew the bleed screw until it starts to drip.
10. When dripping from the bleed screw stops, and the needle on the test kit stabilizes, record the differential pressure. It must be 1 PSID or greater. : If water continues to flow from the bleed screw, the upstream shut-off valve may be leaking. The differential pressure gauge reading is the apparent reading. This gauge reading cannot be validated until it is confirmed that the device is under a no-flow condition.
11. Close the bleed screw.

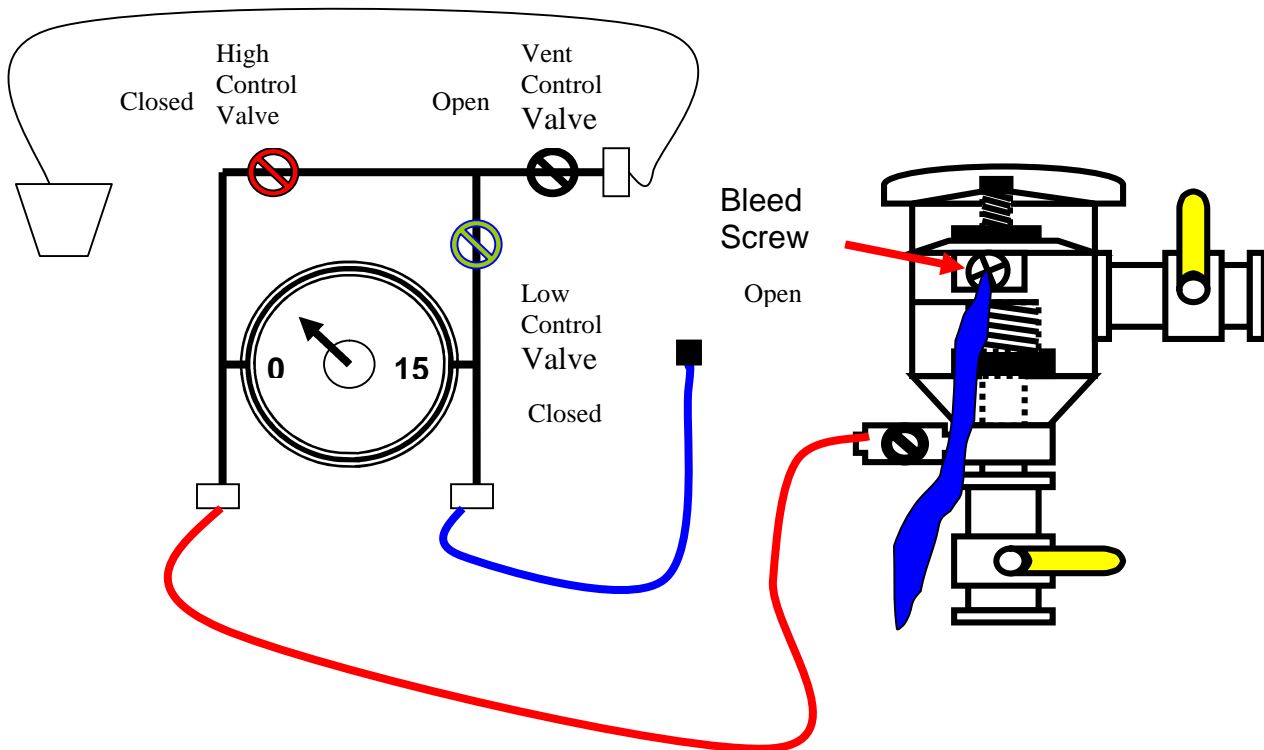

Figure 1

Step 2: Test the downstream shut-off valve for tightness to determine that the device is under a no-flow condition and validate differential pressure reading. (Figure 2)

1. With the high pressure hose still connected to the test cock, open the upstream shut-off valve to pressurize the device. The test kit needle should peg to the extreme right of the gauge.
2. Open the high control valve to bleed air from the hose; close the high control valve.
3. Close the upstream shut-off.
4. Observe needle on the test kit. If the needle remains steady the downstream shut-off valve is holding tight and/or the device is under a no-flow condition. If needle starts to descend, the downstream shut-off valve is considered leaking (See NOTE A).
5. Record data.
6. Proceed to Step 3 if a no-flow condition exists.

NOTE A: If the device is in a flow condition the differential reading taken are invalid. The device does not fail the test, since it cannot be tested in a flow condition. To perform the test of the device, a non-flow condition shall be achieved, either through the repair of the downstream shut-off valve, the operation of an additional shut-off valve downstream or by another means of validating that the device is under a no-flow condition.

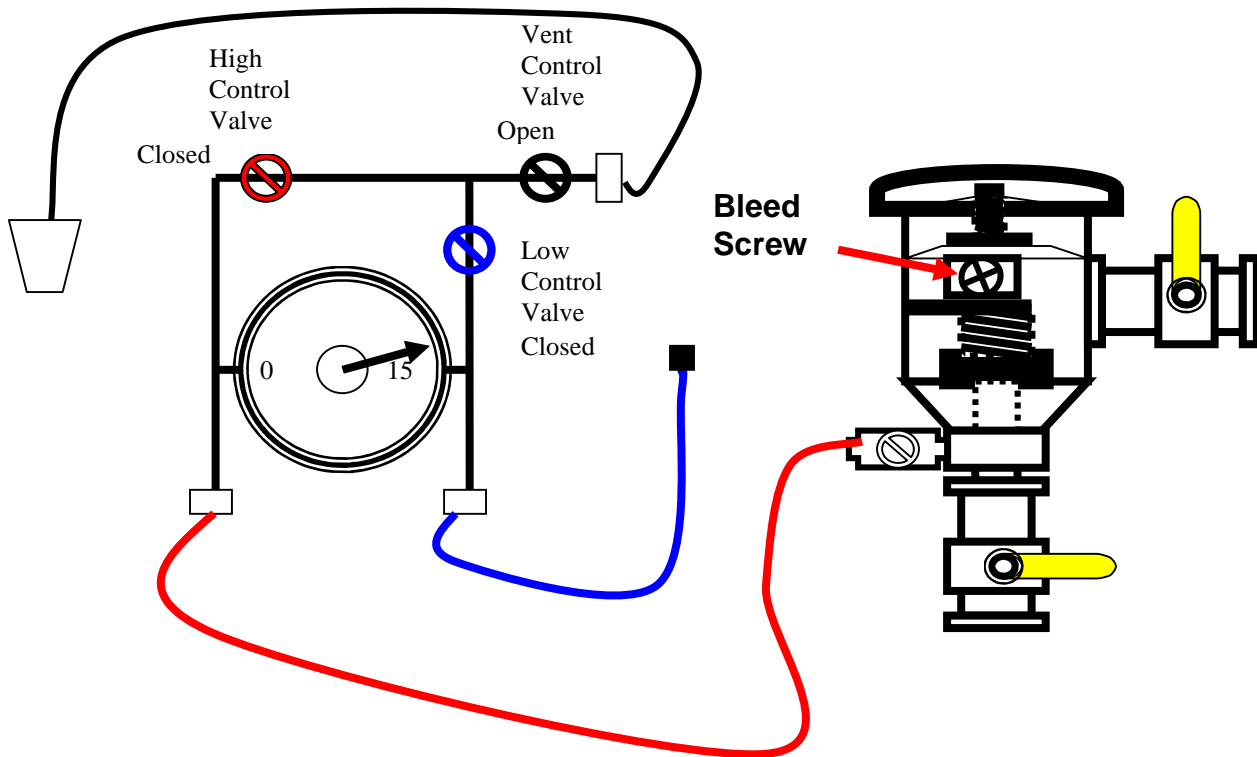

Figure 2

Step 3: Determine if the air inlet valve opens at least 1 PSID above atmospheric pressure. (Figure 3)

1. Both shut-off valves are still closed and the canopy is removed.
2. The high pressure hose is still connected to the open test cock.
3. The test kit valves are positioned as follows: High and low control valves are closed; vent control valves open.
4. Hold the test kit and end of the low pressure hose at the same level as the center of the assembly.
5. Slowly unscrew the bleed screw until it starts to drip.
6. Slowly open the high control valve ¼ turn while simultaneously observing the air inlet valve. (Lightly placing an object on top of the air inlet may be helpful in determine the opening point.)
7. Read the test kit needle at the point where the air inlet valve opens (pops). It should be equal to or greater than 1 PSID. A reading of less than 1 PSID is cause for failure. If the air inlet valve does not open, the upstream shut-off valve may be leaking.
8. Observe that the air inlet valve to determine that it is open completely.

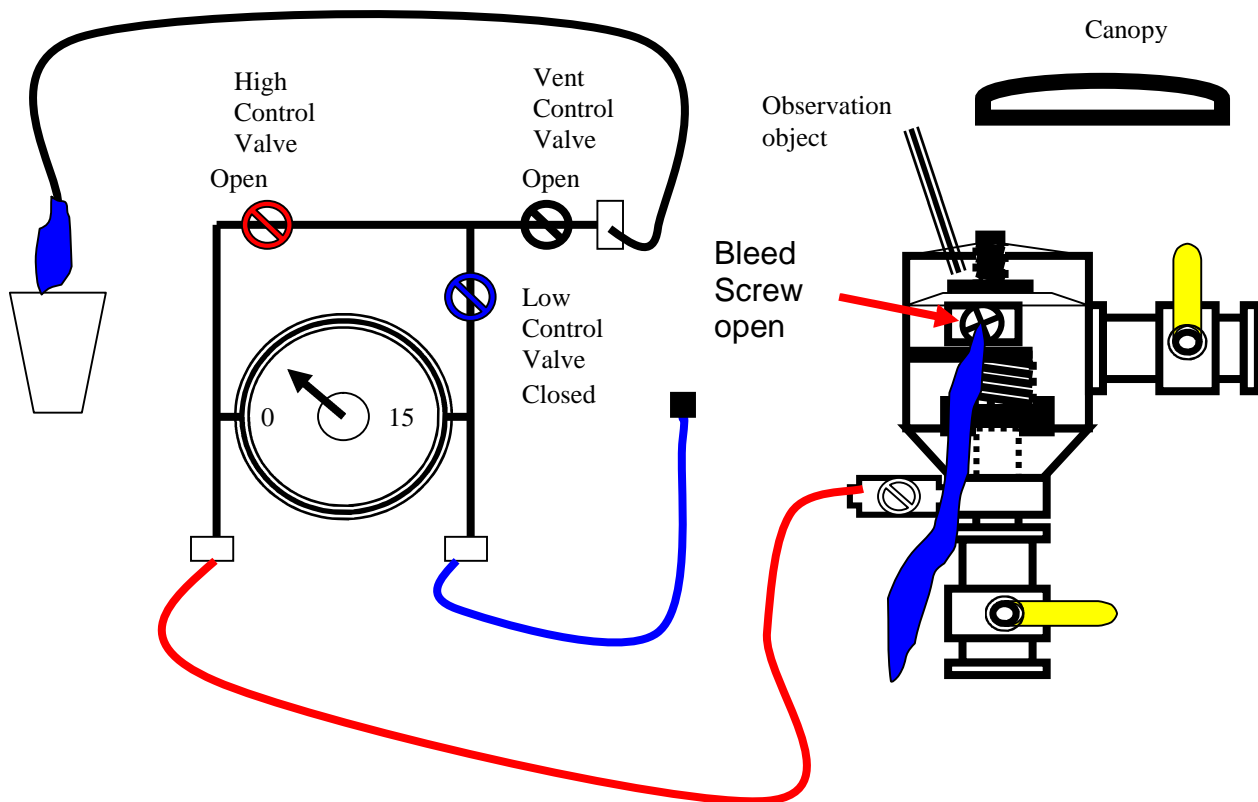

Figure 3

Concluding Procedures This completes the standard field test for a Spill-Resistant Pressure Vacuum Breaker. Before removal of the test equipment, the tester should ensure that the bleed screw and test cock are closed, and the downstream and upstream shut-off valves are open, thereby reestablishing flow. All test data should be recorded on appropriate forms and submitted to the appropriate parties.